

HDG SERIES

SUBMERSIBLE SLURRY DEWATERING PUMPS

POWER : 2~10HP (1.5~7.5kW)
MAX.HEAD : 37m(121feet)
MAX.FLOW : 2.6m³/min (156m³/h)



PRODUCT NOMENCLATURE

Example :

80	HDG	2	1.5
Discharge mm	Type	Pole	kW

FEATURES

- Optimizing HDG series designed with hardened ductile cast iron (FCD-700) agitator, for maximum stirring and pump action for slurry applications.
- Standard accessories include: cable with an epoxy resin sealed water-resistant cable base, Auto-cut motor protector, double mechanical seals, lip oil seal design, and High Solid Epoxy coating.
- High efficient special impeller design in High Chrome Alloy steel (HiCrFC), with a hardness of 55 - 60 Rockwell, to stand high abrasive applications.

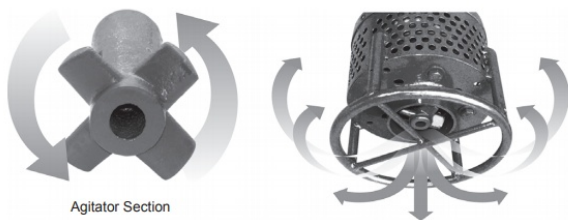

Agitator Section

APPLICATIONS

- Civil engineering, dewatering, tunneling, groundworks, mining and manhole sewer.
- Industrial wastewater dewatering of fluids containing solid sediments.
- Dewatering of slurry mixed with water.
- Portable use for contractors, installers and industry.

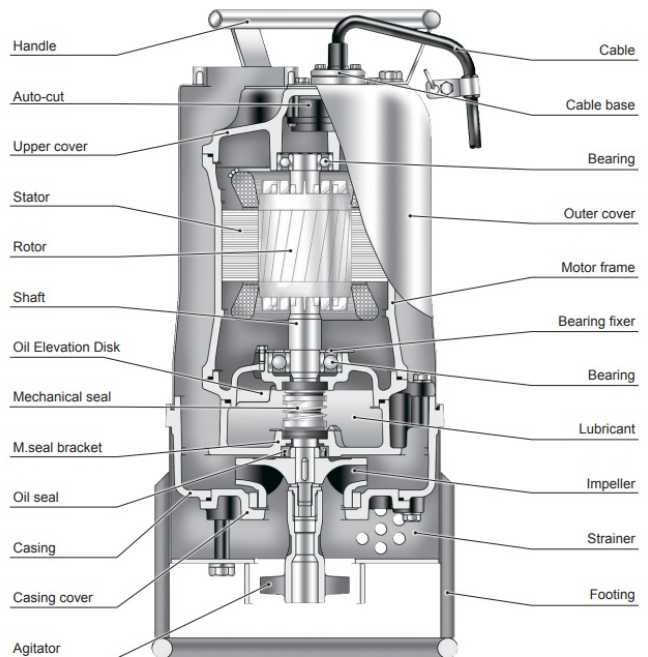

HDG SERIES SUBMERSIBLE SLURRY DEWATERING PUMPS 80HDG21.5 · 80HDG22.2 · 80HDG23.7

SPECIFICATIONS

Item		Description
Limits of Use	Liquid Temp.	0~40°C(32~104°F)
	Applications	Dewatering Fluid Contain Solid Sediment
Type	Frequency	50Hz
	Motor	2P(3000rpm) · Dry Motor
	Insulation	Class F
	Protection	IP68
	Protector	Auto-cut
	Bearing	Ball type
	M.seal	Double M.seals
	Impeller	Close
Material	Upper Cover	FC200
	Motor Frame	FC200
	Shaft	SUS403(2~3HP) · SUS304(5HP)
	M.seal	CA/CE & SIC/SiC
	Casing	FC200
	Impeller	HiCrFC
	Wear ring	HiCrFC
	Agitator	FCD700
	Cable	VCT or H07RN-F
	Optional	-



80HDG21.5 · 80HDG22.2 · 80HDG23.7

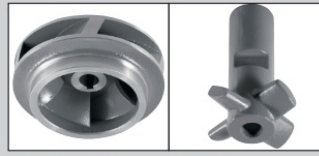

Close Impeller Agitator

Model	Power HP(kW)	Discharge inch(mm)	Standard		MAX		Solid Passage mm(inch)	Weight(W/O Cable)		Phase	Full load Ampere						
			m-m ³ /min	m-m ³ /h	m-m ³ /min	m-m ³ /h		1Ø-kg(lbs)	3Ø-kg(lbs)		1Ø	1Ø	3Ø	3Ø	3Ø	3Ø	3Ø
80HDG21.5	2(1.5)	3"(80)	9-0.5	9-30	15-0.9	15-54	10(3/8")	41(90)	36(79)	Voltage	220V	230V	230V	380V	400V	415V	525V
80HDG22.2	3(2.2)	3"(80)	13-0.5	13-30	20-0.95	20-57	10(3/8")	45(99)	40(88)		15.0	14.6	8.8	5.0	4.8	4.8	3.8
80HDG23.7	5(3.7)	3"(80)	21-0.5	21-30	26.5-1.2	26.5-72	10(3/8")	-	45(99)		-	-	14.2	8.2	7.8	7.8	6.2

PERFORMANCE CURVES

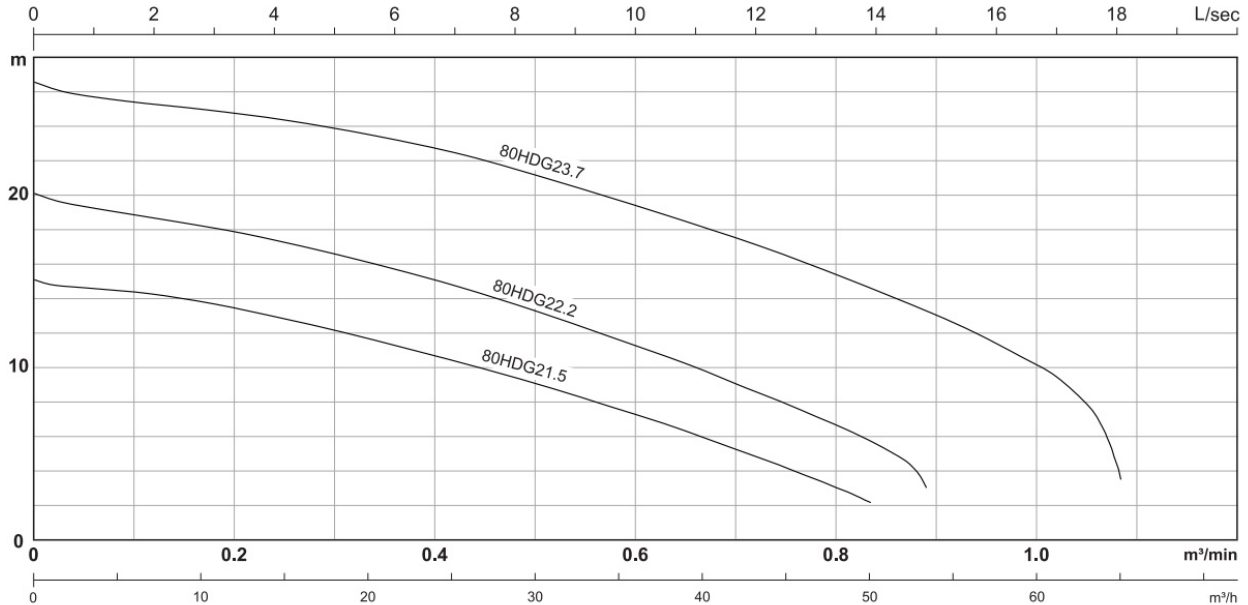

Model	Power HP(kW)	Discharge inch(mm)	Q:m ³ /min Q:m ³ /h	0.1	0.2	0.3	0.4	0.5	0.6	0.8	1.0	Q:L/sec	2	4	6	8	10	12	14	16	
				6	12	18	24	30	36	48	60		H:m	H:m	H:m	H:m	H:m	H:m	H:m	H:m	
80HDG21.5	2(1.5)	3"(80)	H:m	14.0	13.2	12.0	10.7	9.1	7.4	3.0	-	H:m	13.9	12.8	11.1	9.5	7.3	4.8	-	-	
80HDG22.2	3(2.2)	3"(80)		18.9	17.8	16.6	15.2	13.2	11.3	6.6	-		18.5	17.4	15.8	13.6	11.3	8.7	5.4	-	-
80HDG23.7	5(3.7)	3"(80)		25.4	24.4	23.4	22.3	21.0	19.1	15.2	10.1		25.2	24.0	22.8	21.3	19.1	16.8	14.3	11.4	-

HDG SERIES SUBMERSIBLE SLURRY DEWATERING PUMPS

80HDG25.5 · 100HDG25.5 · 100HDG27.5 · 150HDG25.5 · 150HDG27.5

SPECIFICATIONS

Item	Description	
Limits of Use	Liquid Temp.	0~40°C(32~104°F)
	Applications	Dewatering Fluid Contain Solid Sediment
Type	Frequency	50Hz
	Motor	2P(3000rpm) · Dry Motor
	Insulation	Class H
	Protection	IP68
	Protector	Auto-cut
	Bearing	Ball type
	M.seal	Double M.seals
Material	Impeller	Close (80HDG25.5:Open)
	Upper Cover	FC200
	Motor Frame	FC200
	Shaft	SUS304
	M.seal	CA/CE & SiC/SiC
	Casing	FC200
	Impeller	HiCrFC
	Wear plate	HiCrFC(For Open)
	Wear ring	HiCrFC(For Close)
	Agitator	FCD700
	Cable	VCT or H07RN-F
	Optional	-



80HDG25.5 · 100HDG25.5 · 100HDG27.5 · 150HDG25.5 · 150HDG27.5

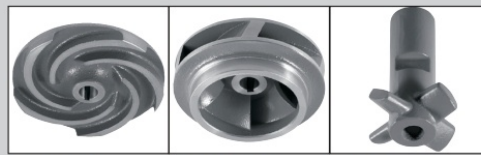

Open Impeller Close Impeller Agitator

Model	Power HP(kW)	Discharge inch(mm)	Standard		MAX		Solid Passage mm(inch)	Weight(W/O Cable)		Phase Voltage	Full load Ampere						
			m-m ³ /min	m-m ³ /h	m-m ³ /min	m-m ³ /h		1Ø-kg(lbs)	3Ø-kg(lbs)		1Ø	1Ø	3Ø	3Ø	3Ø	3Ø	3Ø
80HDG25.5	7.5(5.5)	3"(80)	27-0.5	27-30	37-1.2	37-72	10(3/8")	-	73(161)	Full load Ampere	-	-	21.2	12.0	11.8	11.8	9.3
100HDG25.5	7.5(5.5)	4"(100)	18-1.0	18-60	25-1.9	25-114	10(3/8")	-	76(168)		-	-	21.2	12.0	11.8	11.8	9.3
100HDG27.5	10(7.5)	4"(100)	24.5-1.0	24.5-60	35-1.8	35-108	10(3/8")	-	81(179)		-	-	28.6	16.0	15.8	15.8	12.6
150HDG25.5	7.5(5.5)	6"(150)	11-1.5	11-90	22-2.3	22-138	10(3/8")	-	79(174)		-	-	21.2	12.0	11.8	11.8	9.3
150HDG27.5	10(7.5)	6"(150)	16-1.5	16-90	26-2.6	26-156	10(3/8")	-	82(181)		-	-	28.6	16.0	15.8	15.8	12.6

PERFORMANCE CURVES

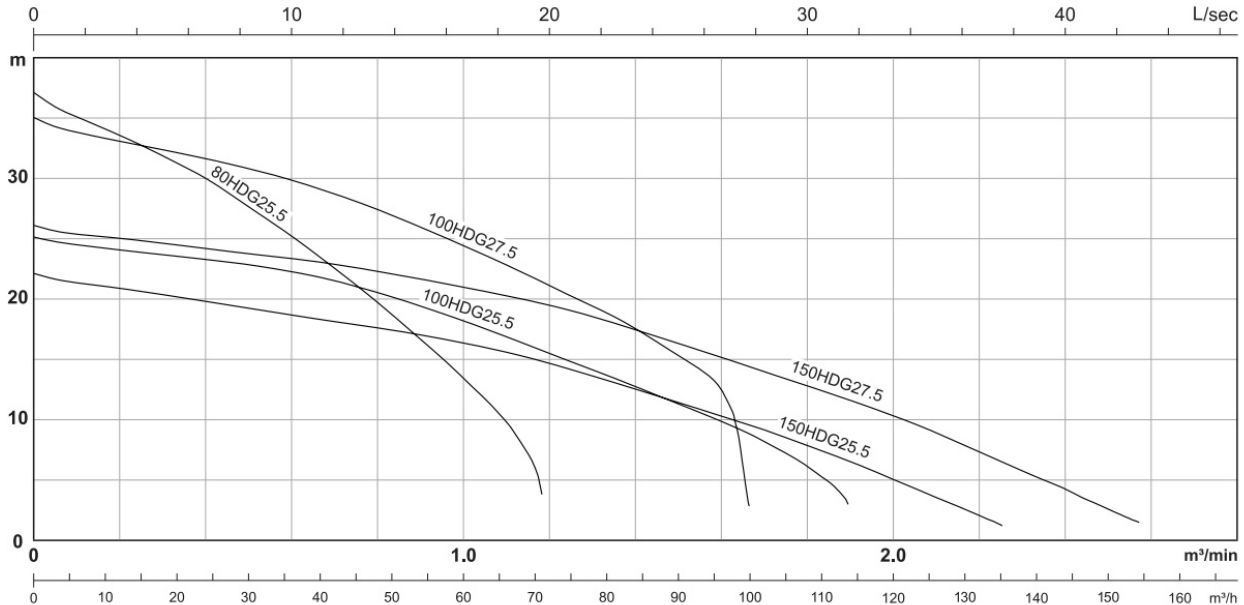

Model	Power HP(kW)	Discharge inch(mm)	Q:m ³ /min Q:m ³ /h	H:m										Q:L/sec												
				0.2	0.4	0.6	0.8	1.2	1.6	2.0	2.4	5	10	15	20	25	30	35	40							
80HDG25.5	7.5(5.5)	3"(80)	33.6 12	30.0 24	25.0 20	19.6 16	-	-	-	-	-	-	-	-	-	-	-	32.0	25.0	16.6	-	-	-	-	-	
100HDG25.5	7.5(5.5)	4"(100)	24.0 12	23.0 10	22.0 10	20.6 9	15.3 7	9.8 5	-	-	-	-	-	-	-	-	-	32.8	29.7	25.8	21.2	15.4	-	-	-	-
100HDG27.5	10(7.5)	4"(100)	33.6 12	31.8 11	29.7 11	27.2 10	21.2 9	11.4 5	-	-	-	-	-	-	-	-	-	20.2	18.6	16.8	14.4	11.3	7.6	3.6	-	-
150HDG25.5	7.5(5.5)	6"(150)	20.8 12	19.7 9	18.6 9	17.5 8	14.4 6	10.1 5	5.0 3	-	-	-	-	-	-	-	-	24.6	23.2	21.5	19.1	15.8	12.4	8.4	3.8	-
150HDG27.5	10(7.5)	6"(150)	25.1 12	24.0 11	23.2 10	22.1 9	19.1 8	14.8 7	9.8 5	-	-	-	-	-	-	-	-	-	-	-	-	-	-	-	-	-

HCP PUMP

PUMP PERFORMANCE CURVES

Model	80HDG21.5				Ver NO.	BB0419	
Frequency / Phase	50 Hz / 1 Ø				REFERENCE SPECIFICATION		
Discharge	3" / 80 mm						
Power	2 HP / 1.5 kW						
Std. Head	9 m						
Std. Capacity	0.5 m ³ /min						
Volt	220 V	230 V	240 V				
Rated Current	10.2 A	10 A	9.8 A				
Pole / rpm	2 P / 2800 rpm						
Start Method	CAPACITOR						
Insulation Class	F						

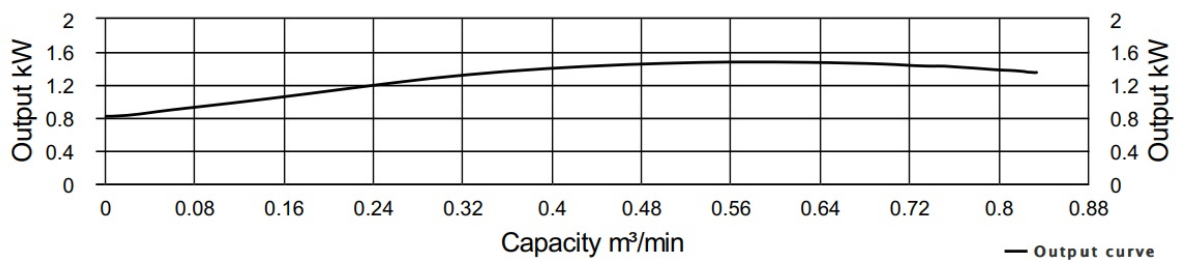
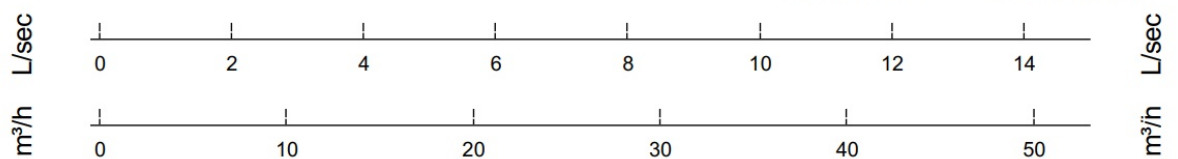
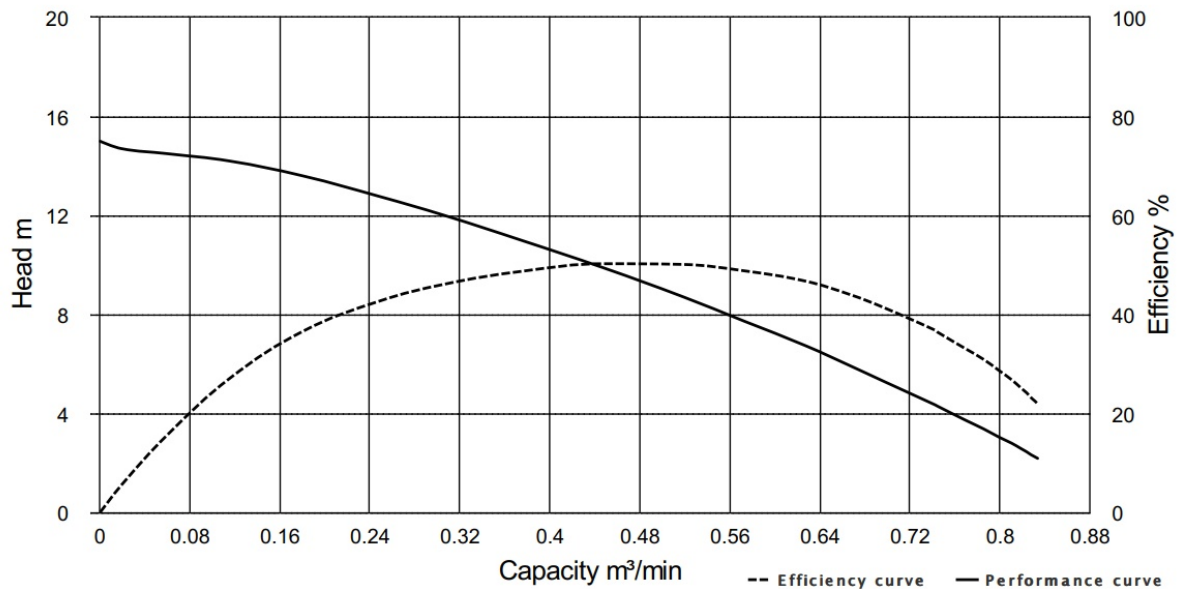

HCP PUMP MANUFACTURER CO., LTD.

HCP PUMP

PUMP PERFORMANCE CURVES

Model	80HDG21.5					Ver NO.	BB0419	
Frequency / Phase	50 Hz / 3 Ø					REFERENCE SPECIFICATION		
Discharge	3" / 80 mm							
Power	2 HP / 1.5 kW							
Std. Head	9 m							
Std. Capacity	0.5 m ³ /min							
Volt	230 V	380 V	400 V	415 V	525 V			
Rated Current	6.2 A	3.6 A	3.4 A	3.4 A	2.7 A			
Pole / rpm	2 P / 2800 rpm							
Start Method	DOL							
Insulation Class	F							

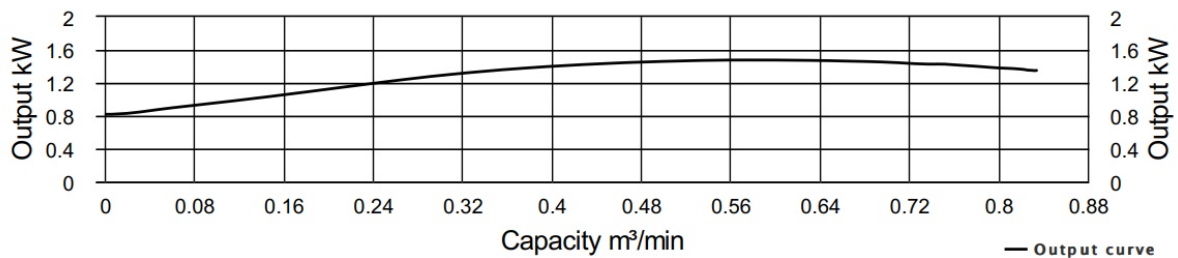
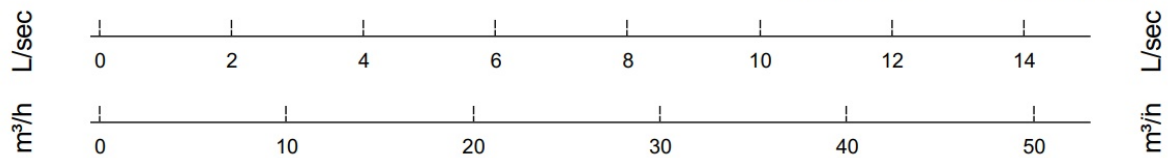
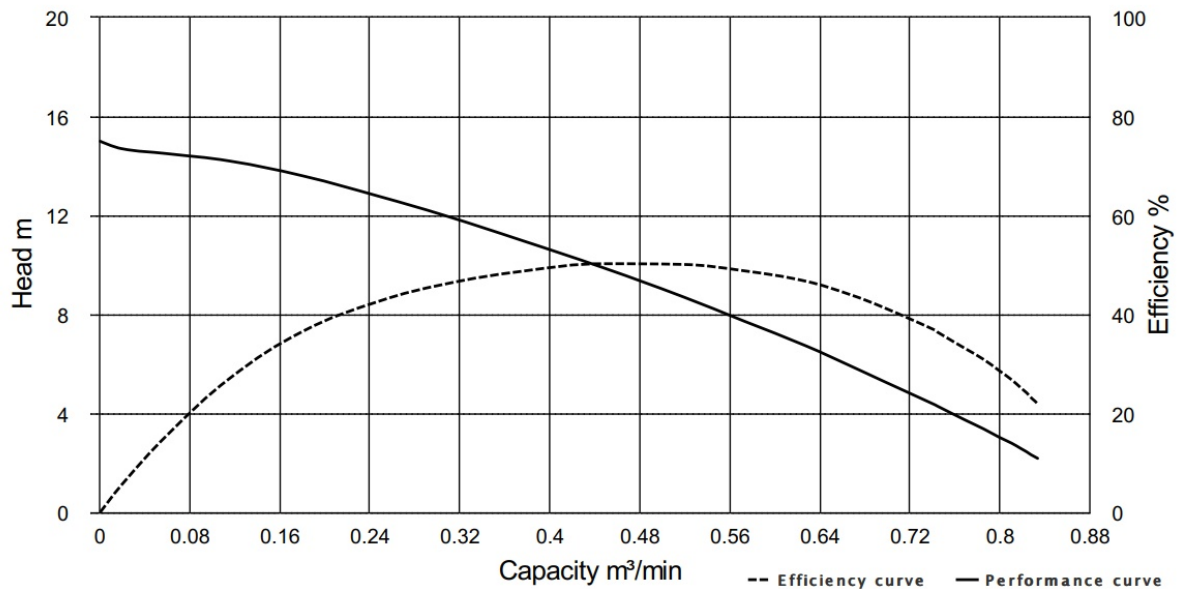

HCP PUMP MANUFACTURER CO., LTD.

HCP PUMP

PUMP PERFORMANCE CURVES

Model	80HDG22.2				Ver NO.	BB0419	
Frequency / Phase	50 Hz / 1 Ø				REFERENCE SPECIFICATION		
Discharge	3" / 80 mm						
Power	3 HP / 2.2 kW						
Std. Head	13 m						
Std. Capacity	0.5 m ³ /min						
Volt	220 V	230 V	240 V				
Rated Current	15 A	14.6 A	14.4 A				
Pole / rpm	2 P / 2820 rpm						
Start Method	CAPACITOR						
Insulation Class	F						

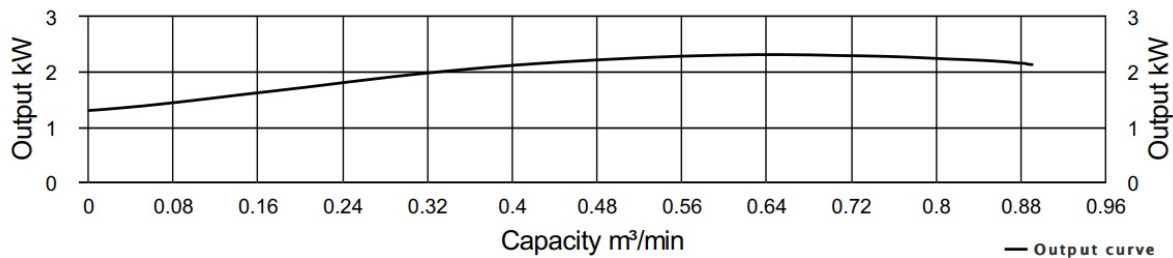
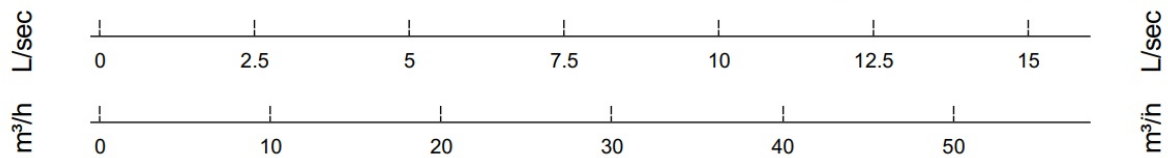
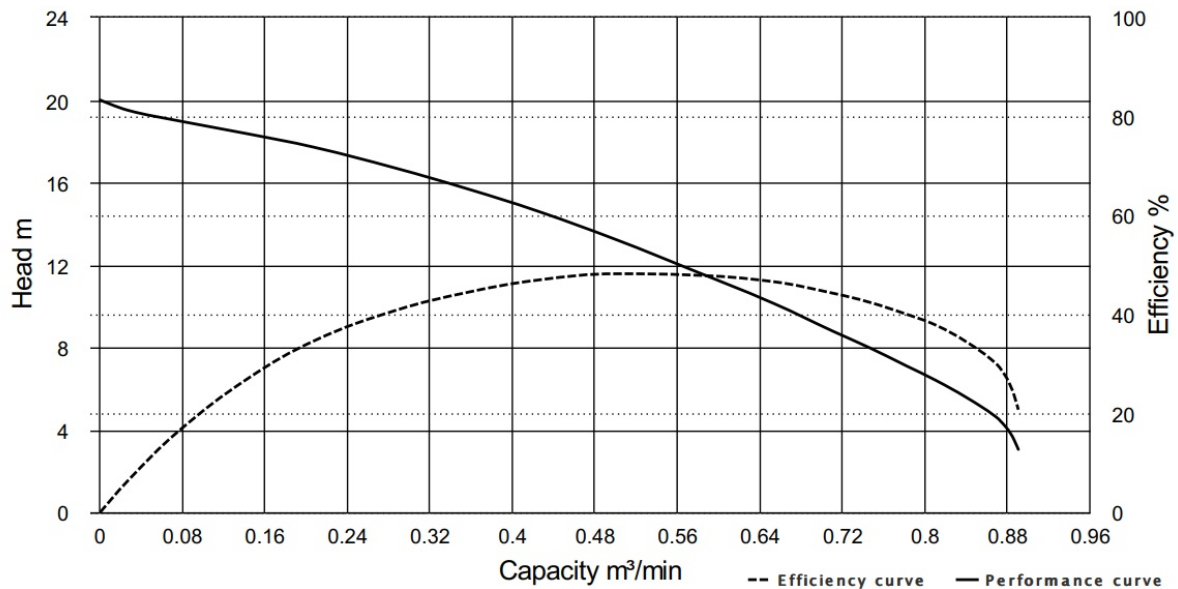

HCP PUMP MANUFACTURER CO., LTD.

HCP PUMP

PUMP PERFORMANCE CURVES

Model	80HDG22.2					Ver NO.	BB0419	
Frequency / Phase	50 Hz / 3 Ø					REFERENCE SPECIFICATION		
Discharge	3" / 80 mm							
Power	3 HP / 2.2 kW							
Std. Head	13 m							
Std. Capacity	0.5 m ³ /min							
Volt	230 V	380 V	400 V	415 V	525 V			
Rated Current	8.8 A	5 A	4.8 A	4.8 A	3.8 A			
Pole / rpm	2 P / 2820 rpm							
Start Method	DOL							
Insulation Class	F							

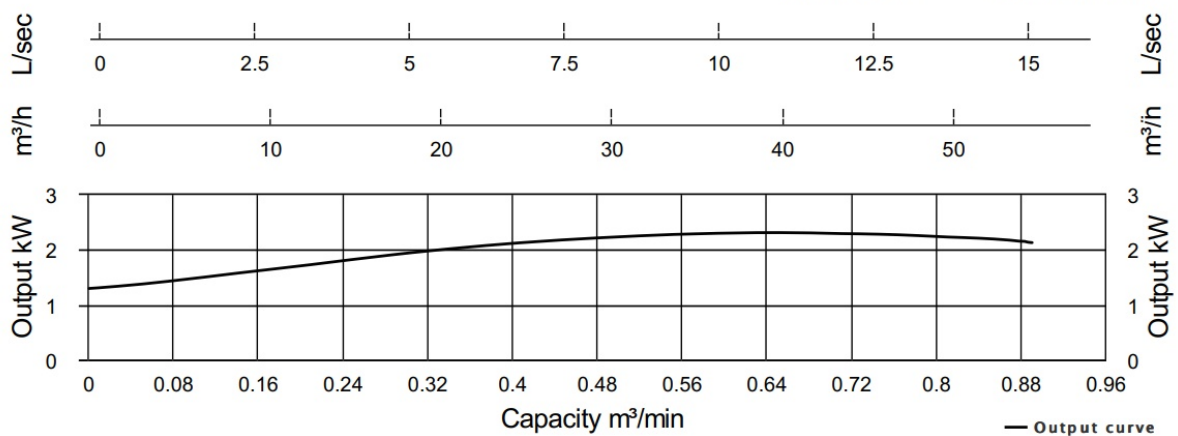
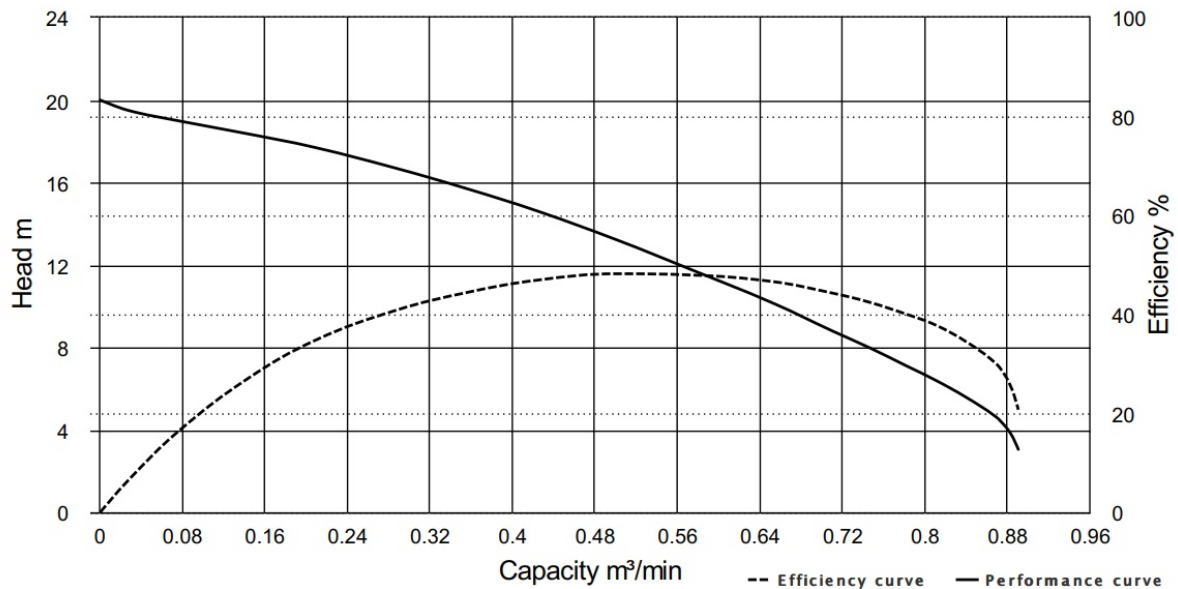

HCP PUMP MANUFACTURER CO., LTD.

HCP PUMP

PUMP PERFORMANCE CURVES

Model	80HDG23.7					Ver NO.	BB0419	
Frequency / Phase	50 Hz / 3 Ø					REFERENCE SPECIFICATION		
Discharge	3" / 80 mm							
Power	5 HP / 3.7 kW							
Std. Head	21 m							
Std. Capacity	0.5 m³/min							
Volt	230 V	380 V	400 V	415 V	525 V			
Rated Current	14.2 A	8.2 A	7.8 A	7.8 A	6.2 A			
Pole / rpm	2 P / 2800 rpm							
Start Method	DOL							
Insulation Class	F							

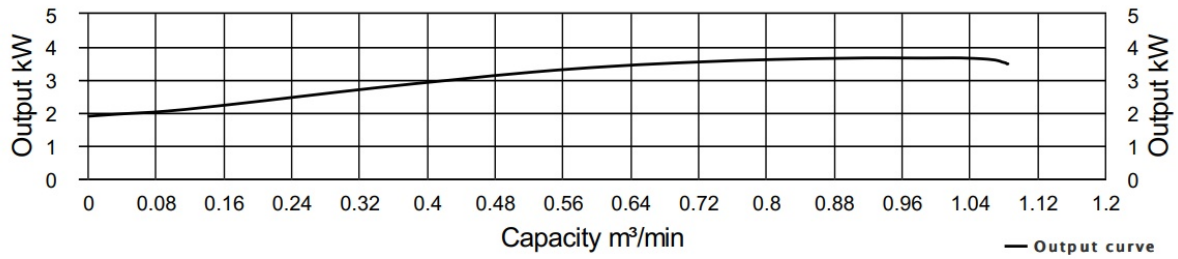
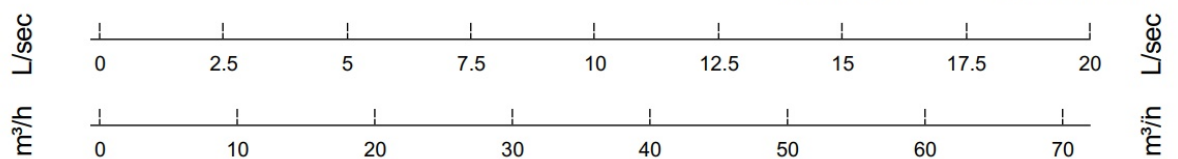
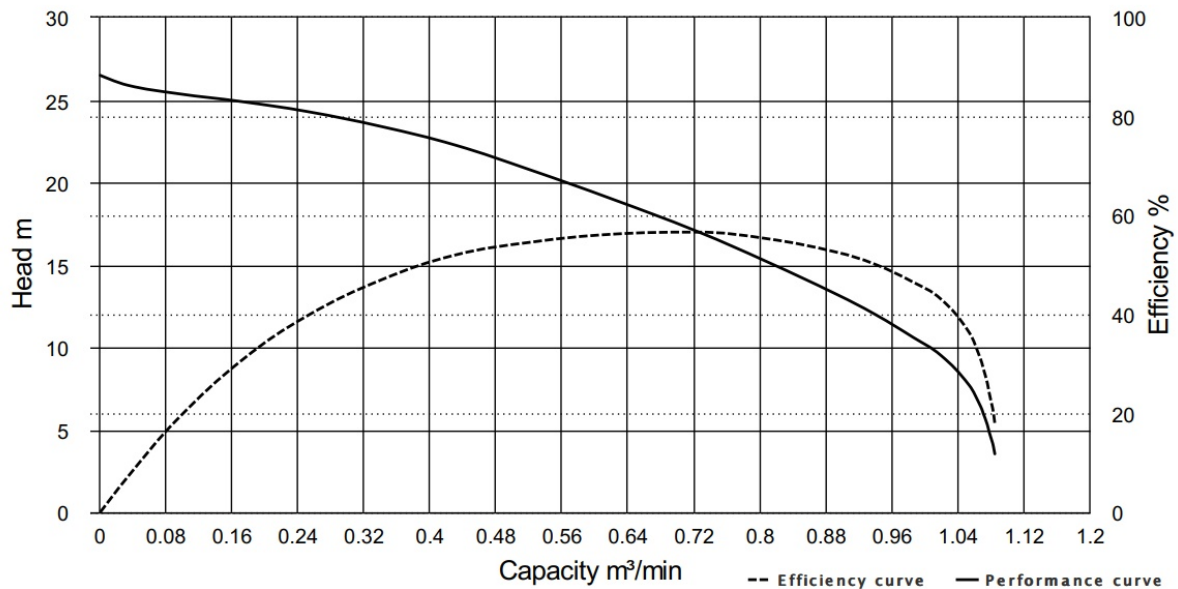

HCP PUMP MANUFACTURER CO., LTD.

HCP PUMP

PUMP PERFORMANCE CURVES

Model	80HDG25.5					Ver NO.	BB0419	
Frequency / Phase	50 Hz / 3 Ø					REFERENCE SPECIFICATION		
Discharge	3" / 80 mm							
Power	7.5 HP / 5.5 kW							
Std. Head	27 m							
Std. Capacity	0.5 m ³ /min							
Volt	230 V	380 V	400 V	415 V	525 V			
Rated Current	21.2 A	12 A	11.8 A	11.8 A	9.3 A			
Pole / rpm	2 P / 2850 rpm							
Start Method	DOL							
Insulation Class	H							

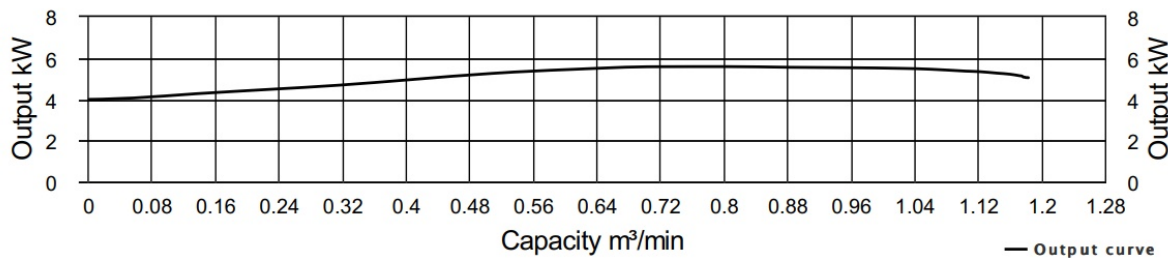
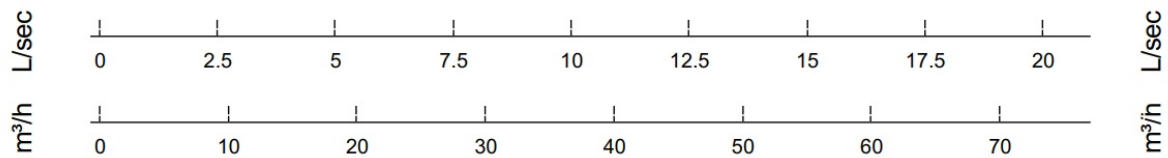
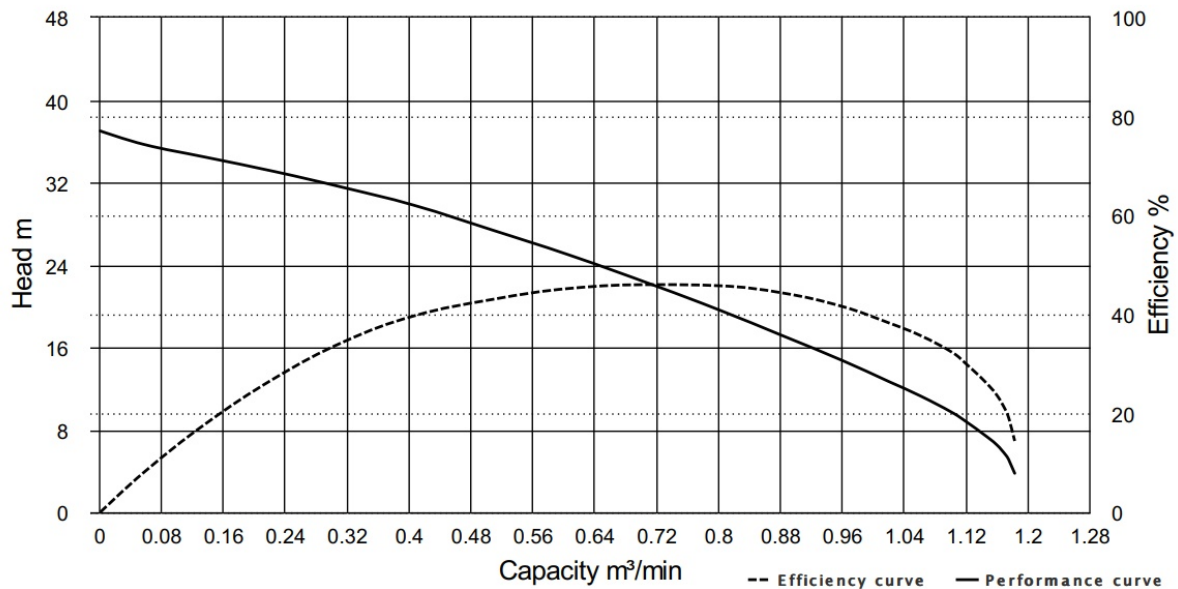

HCP PUMP MANUFACTURER CO., LTD.

HCP PUMP

PUMP PERFORMANCE CURVES

Model	100HDG25.5					Ver NO.	BB0419	
Frequency / Phase	50 Hz / 3 Ø					REFERENCE SPECIFICATION		
Discharge	4" / 100 mm							
Power	7.5 HP / 5.5 kW							
Std. Head	18 m							
Std. Capacity	1 m ³ /min							
Volt	230 V	380 V	400 V	415 V	525 V			
Rated Current	21.2 A	12 A	11.8 A	11.8 A	9.3 A			
Pole / rpm	2 P / 2850 rpm							
Start Method	DOL							
Insulation Class	H							

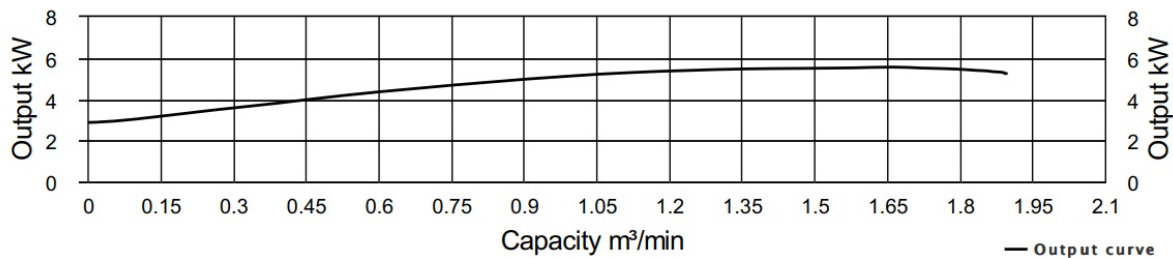
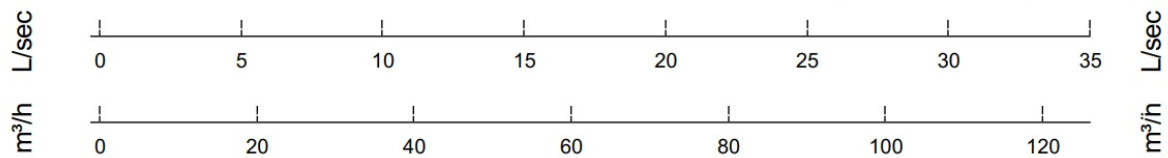
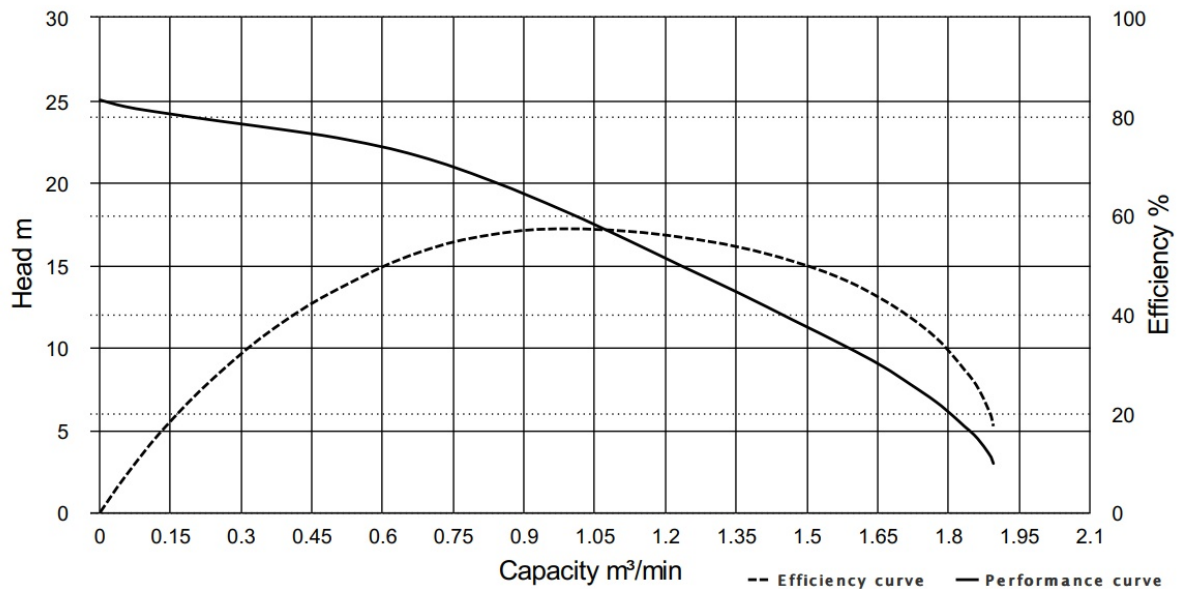

HCP PUMP MANUFACTURER CO., LTD.

HCP PUMP

PUMP PERFORMANCE CURVES

Model	100HDG27.5					Ver NO.	BB0419	
Frequency / Phase	50 Hz / 3 Ø					REFERENCE SPECIFICATION		
Discharge	4" / 100 mm							
Power	10 HP / 7.5 kW							
Std. Head	24 m							
Std. Capacity	1 m ³ /min							
Volt	230 V	380 V	400 V	415 V	525 V			
Rated Current	28.6 A	16 A	15.8 A	15.8 A	12.6 A			
Pole / rpm	2 P / 2850 rpm							
Start Method	DOL							
Insulation Class	H							

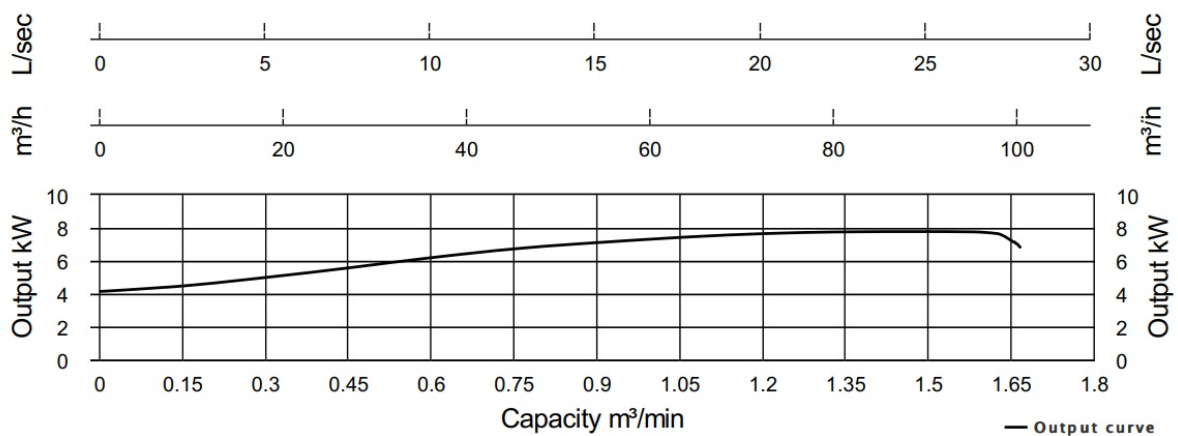
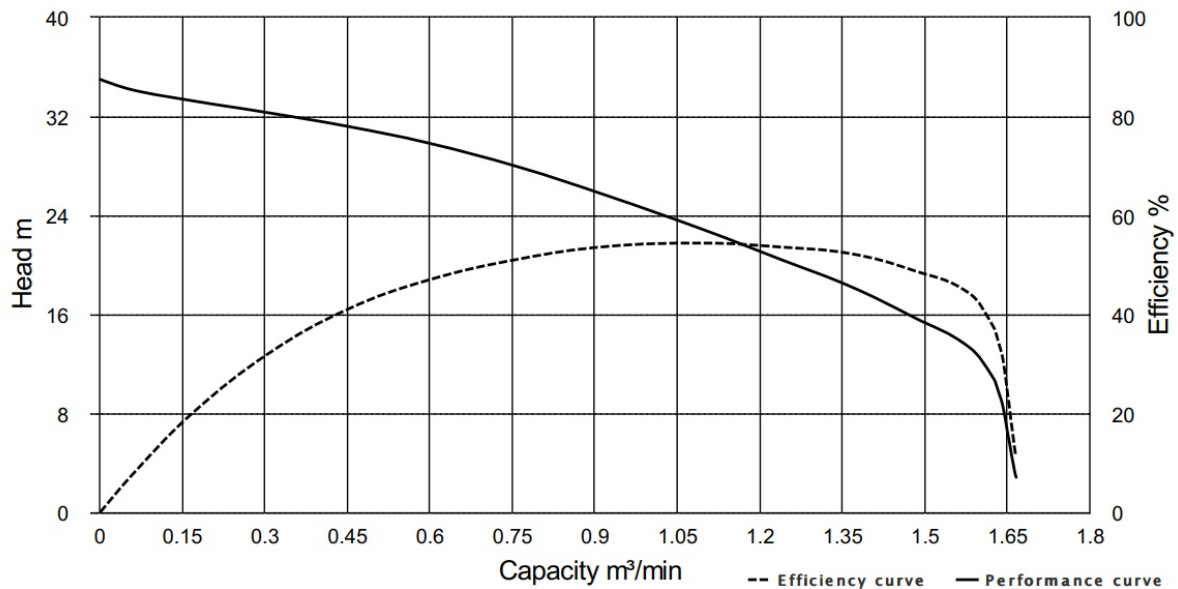

HCP PUMP MANUFACTURER CO., LTD.

HCP PUMP

PUMP PERFORMANCE CURVES

Model	150HDG25.5					Ver NO.	BB0419	
Frequency / Phase	50 Hz / 3 Ø					REFERENCE SPECIFICATION		
Discharge	6" / 150 mm							
Power	7.5 HP / 5.5 kW							
Std. Head	11 m							
Std. Capacity	1.5 m ³ /min							
Volt	230 V	380 V	400 V	415 V	525 V			
Rated Current	21.2 A	12 A	11.8 A	11.8 A	9.3 A			
Pole / rpm	2 P / 2850 rpm							
Start Method	DOL							
Insulation Class	H							

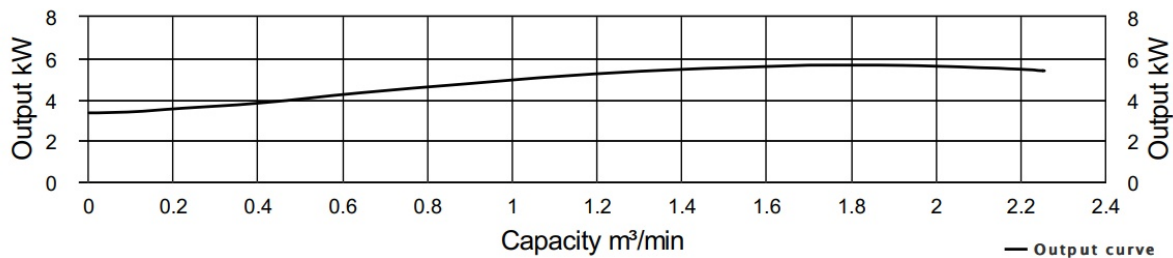
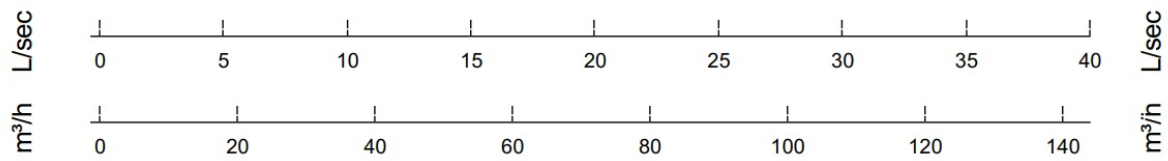
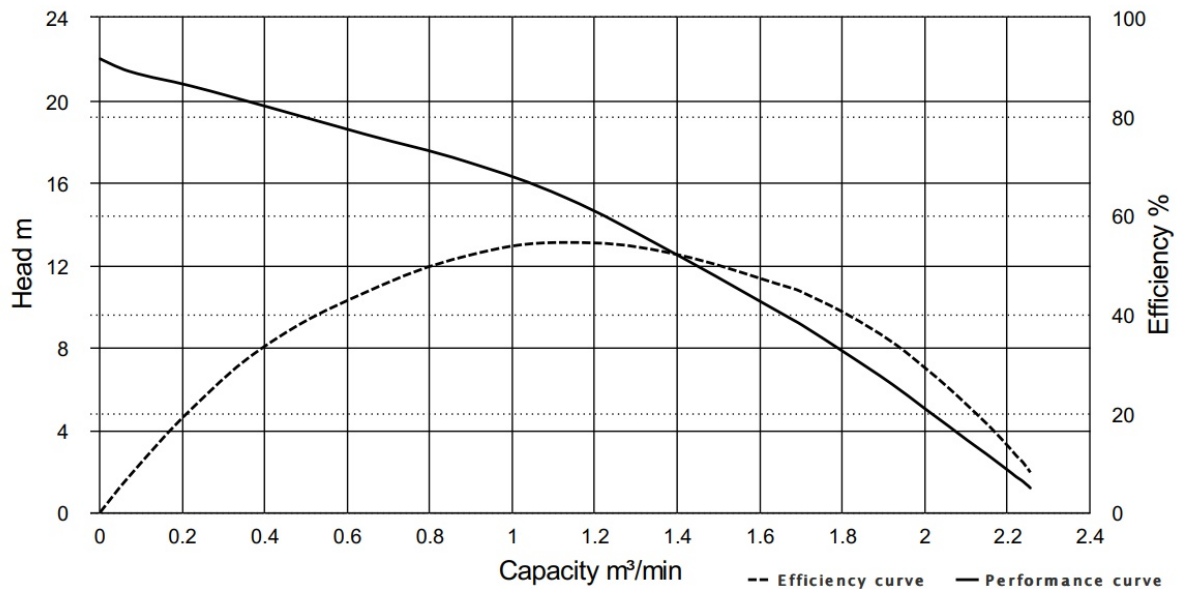

HCP PUMP MANUFACTURER CO., LTD.



HCP PUMP

PUMP PERFORMANCE CURVES

Model	150HDG27.5					Ver NO.	BB0419	
Frequency / Phase	50 Hz / 3 Ø					REFERENCE SPECIFICATION		
Discharge	6" / 150 mm							
Power	10 HP / 7.5 kW							
Std. Head	16 m							
Std. Capacity	1.5 m ³ /min							
Volt	230 V	380 V	400 V	415 V	525 V			
Rated Current	28.6 A	16 A	15.8 A	15.8 A	12.6 A			
Pole / rpm	2 P / 2850 rpm							
Start Method	DOL							
Insulation Class	H							

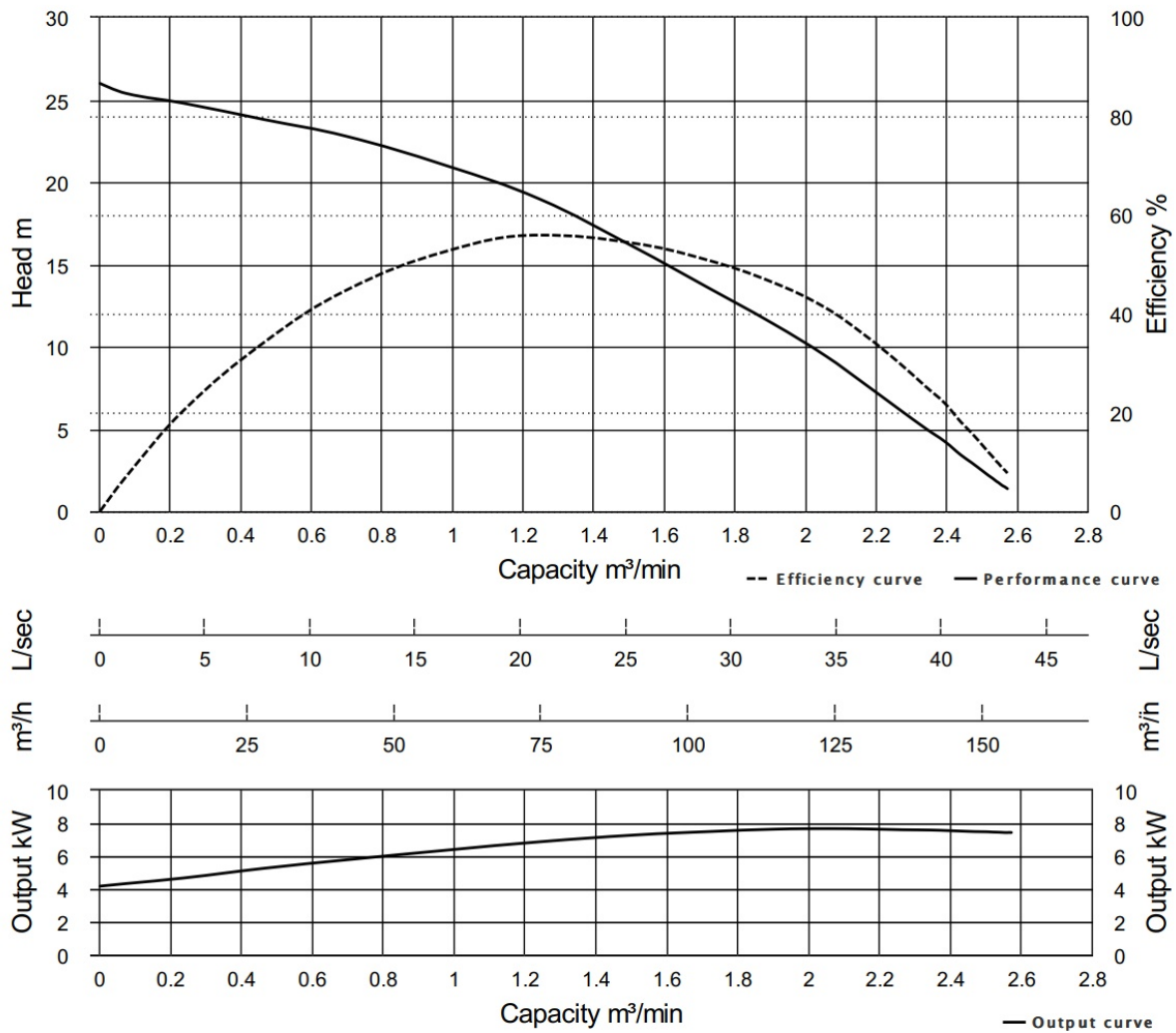

HCP PUMP MANUFACTURER CO., LTD.

HCP PUMP

HDG SERIES

DIMENSIONS

NO: S3HDG237030-00

MODEL: 80HDG21.5 / 22.2 / 23.7

60Hz 1Ø / 3Ø

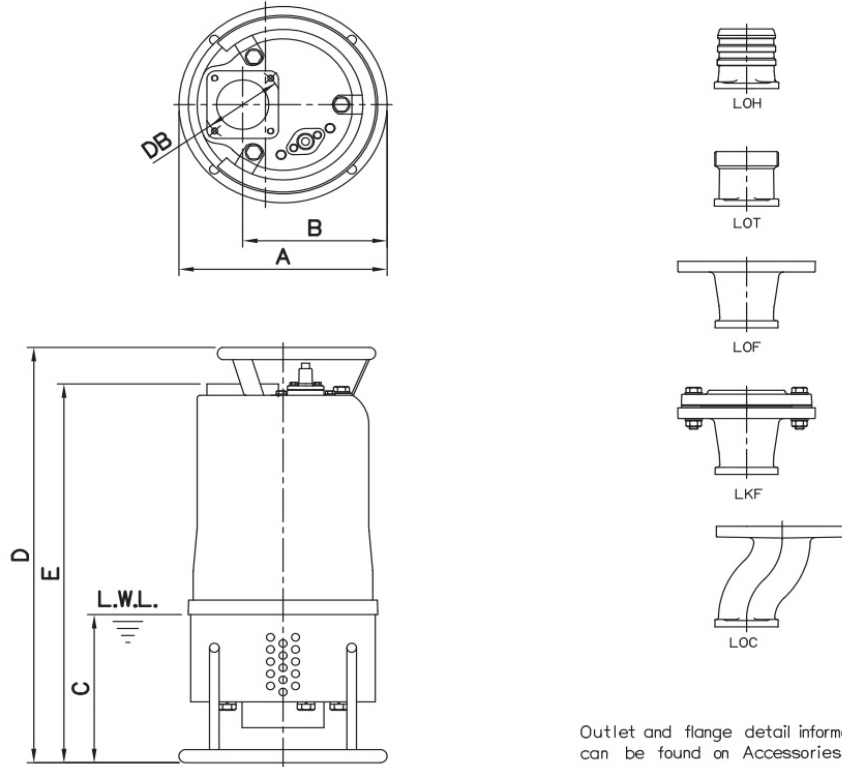

Outlet and flange detail information can be found on Accessories section.

Dimensions—mm

Weight:kg

Model	A	B	C	D	E	DB	WT1	Optional Outlet Accessories				
								LOH	LOT	LOF	LKF	LOC
80HDG21.5 1Ø	260	179	195	592	546	98	41	LOH3-98	LOT3-98	LOF3-150-160*98	LKF3-150*98	LOC3-150*98
80HDG21.5 3Ø	260	179	195	547	502	98	36	LOH3-98	LOT3-98	LOF3-150-160*98	LKF3-150*98	LOC3-150*98
80HDG22.2 1Ø	260	179	195	622	577	98	45	LOH3-98	LOT3-98	LOF3-150-160*98	LKF3-150*98	LOC3-150*98
80HDG22.2 3Ø	260	179	195	547	502	98	40	LOH3-98	LOT3-98	LOF3-150-160*98	LKF3-150*98	LOC3-150*98
80HDG23.7 3Ø	260	179	195	577	532	98	45	LOH3-98	LOT3-98	LOF3-150-160*98	LKF3-150*98	LOC3-150*98

Dimensions—inch

Weight:lb

Model	A	B	C	D	E	DB	WT1	Optional Outlet Accessories				
								LOH	LOT	LOF	LKF	LOC
80HDG21.5 1Ø	10¼	7½	7½	23½	21½	3⅞	90	LOH3-98	LOT3-98	LOF3-150-160*98	LKF3-150*98	LOC3-150*98
80HDG21.5 3Ø	10¼	7½	7½	21½	19¾	3⅞	79	LOH3-98	LOT3-98	LOF3-150-160*98	LKF3-150*98	LOC3-150*98
80HDG22.2 1Ø	10¼	7½	7½	24½	22½	3⅞	99	LOH3-98	LOT3-98	LOF3-150-160*98	LKF3-150*98	LOC3-150*98
80HDG22.2 3Ø	10¼	7½	7½	21½	19¾	3⅞	88	LOH3-98	LOT3-98	LOF3-150-160*98	LKF3-150*98	LOC3-150*98
80HDG23.7 3Ø	10¼	7½	7½	22½	20¾	3⅞	99	LOH3-98	LOT3-98	LOF3-150-160*98	LKF3-150*98	LOC3-150*98

L.W.L.:Lowest Running Water Level

WT1: Pump Weight (Without Cable)

HCP PUMP

HDG SERIES

DIMENSIONS

NO: S6HDG275030-00

MODEL: 80HDG25.5 & 100HDG25.5 / 27.5 & 150HDG25.5 / 27.5

50Hz 3Ø

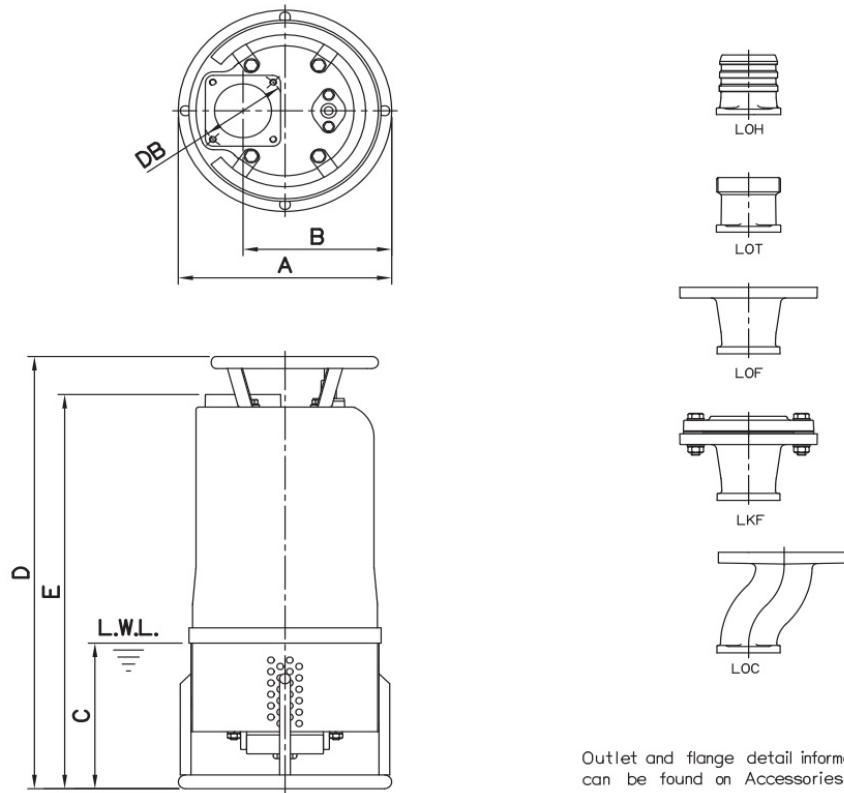

Outlet and flange detail information can be found on Accessories section.

Dimensions-mm

Weight:kg

Model	A	B	C	D	E	DB	WT1	Optional Outlet Accessories				
								LOH	LOT	LOF	LKF	LOC
80HDG25.5	318	221	200	683	623	127	73	LOH3-127	LOT3-127	LOF3-150-160*127	LKF3-150*127	LOC3-150*127
100HDG25.5	318	221	200	683	623	127	76	LOH4-127	LOT4-127	LOF4-175-190*127	LKF4-175*127	-
100HDG27.5	318	221	200	683	623	127	81	LOH4-127	LOT4-127	LOF4-175-190*127	LKF4-175*127	-
150HDG25.5	318	221	200	683	623	127	79	LOH6-127	LOT6-127	LOF6-240*127	LKF6-240*127	-
150HDG27.5	318	221	200	683	623	127	82	LOH6-127	LOT6-127	LOF6-240*127	LKF6-240*127	-

Dimensions-inch

Weight:lb

Model	A	B	C	D	E	DB	WT1	Optional Outlet Accessories				
								LOH	LOT	LOF	LKF	LOC
80HDG25.5	12 $\frac{1}{2}$	8 $\frac{5}{16}$	7 $\frac{7}{8}$	26 $\frac{3}{8}$	24 $\frac{1}{2}$	5	161	LOH3-127	LOT3-127	LOF3-150-160*127	LKF3-150*127	LOC3-150*127
100HDG25.5	12 $\frac{1}{2}$	8 $\frac{5}{16}$	7 $\frac{7}{8}$	26 $\frac{3}{8}$	24 $\frac{1}{2}$	5	168	LOH4-127	LOT4-127	LOF4-175-190*127	LKF4-175*127	-
100HDG27.5	12 $\frac{1}{2}$	8 $\frac{5}{16}$	7 $\frac{7}{8}$	26 $\frac{3}{8}$	24 $\frac{1}{2}$	5	179	LOH4-127	LOT4-127	LOF4-175-190*127	LKF4-175*127	-
150HDG25.5	12 $\frac{1}{2}$	8 $\frac{5}{16}$	7 $\frac{7}{8}$	26 $\frac{3}{8}$	24 $\frac{1}{2}$	5	174	LOH6-127	LOT6-127	LOF6-240*127	LKF6-240*127	-
150HDG27.5	12 $\frac{1}{2}$	8 $\frac{5}{16}$	7 $\frac{7}{8}$	26 $\frac{3}{8}$	24 $\frac{1}{2}$	5	181	LOH6-127	LOT6-127	LOF6-240*127	LKF6-240*127	-

L.W.L.:Lowest Running Water Level

WT1: Pump Weight (Without Cable)

HCP PUMP

HDG SERIES

DIMENSIONS

NO: SOHDG000000-00

MODEL: Outlet (3"~6")

OUTLET CONNECTION

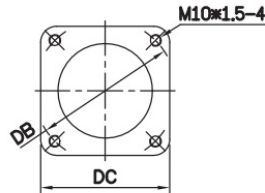

Model	mm		inch	
	DB	DC	DB	DC
1.5~3.7kW	98	89	3 7/8	3 1/2
5.5~7.5kW	127	112	5	4 1/8

OPTIONAL OUTLET ACCESSORIES

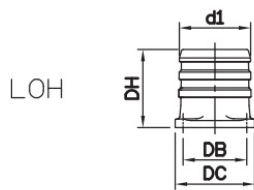

LOH	Dimensions-mm				kg	Dimensions-inch				lb
	d1	DB	DC	DH		d1	DB	DC	DH	
LOH3-98	80	98	89	100	2	3	3 7/8	3 1/2	3 3/8	4
LOH3-127	80	127	112	110	2	3	5	4 1/8	4 5/8	4
LOH4-127	100	127	112	110	3	4	5	4 7/8	4 5/8	7
LOH6-127	150	127	112	172	5	6	5	4 7/8	6 3/4	11

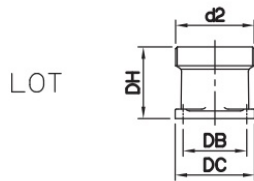

LOT	Dimensions-mm				kg	Dimensions-inch				lb	Thread Available		
	d2	DB	DC	DH		Weight	d2	DB	DC		DH	Weight	PF
LOT3-98	80	98	89	80	2	3	3 7/8	3 1/2	3 3/8	4	PF	PT	NPT
LOT3-127	80	127	112	85	2	3	5	4 1/8	3 3/8	4	PF	PT	NPT
LOT4-127	100	127	112	85	2	4	5	4 1/8	3 3/8	4	PF	PT	NPT
LOT6-127	150	127	112	140	4	6	5	4 7/8	5 1/2	9	PF	PT	NPT

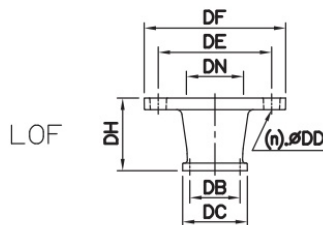

LOF	Dimensions-mm								kg	Dimensions-inch								lb	(n)QTY
	DN	DB	DC	DD	DE	DF	DH	Weight		DN	DB	DC	DD	DE	DF	DH	Weight		
LOF3-150-160x98	80	98	89	19	150~160	195	100	4	3	3 7/8	3 1/2	3/4	5 3/4~6 5/8	7 1/8	3 1/8	9	8		
LOF3-150-160x127	80	127	112	19	150~160	195	110	7	3	5	4 1/8	3/4	5 3/4~6 5/8	7 1/8	4 5/8	15	8		
LOF4-175-190x127	100	127	112	19	175~190	225	110	10	4	5	4 1/8	3/4	6 1/8~7 1/2	8 7/8	4 5/8	22	8		
LOF6-240x127	150	127	112	23	240	280	140	14	6	5	4 1/8	7/8	9 1/8	11	5 1/2	31	8		

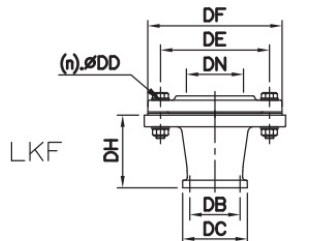

LKF	Dimensions-mm								kg	Dimensions-inch								lb	(n)QTY	Thread Available	
	DN	DB	DC	DD	DE	DF	DH	Weight		DN	DB	DC	DD	DE	DF	DH	Weight			PT	NPT
LKF3-150x98	80	98	89	15	150	185	100	8	3	3 7/8	3 1/2	3/8	5 3/4	7 5/8	3 3/8	18	8	PT	NPT		
LKF3-150x127	80	127	112	15	150	185	110	8	3	5	4 1/8	3/8	5 3/4	7 5/8	4 5/8	15	8	PT	NPT		
LKF4-175x127	100	127	112	15	175	210	110	10	4	5	4 1/8	3/8	6 1/4	8 3/4	4 5/8	22	8	PT	NPT		
LKF6-240x127	150	127	112	23	240	280	140	20	6	5	4 1/8	7/8	9 1/8	11	5 1/2	44	8	PT	NPT		

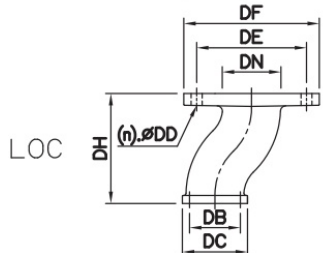

LOC	Dimensions-mm								kg	Dimensions-inch								lb	(n)QTY
	DN	DB	DC	DD	DE	DF	DH	Weight		DN	DB	DC	DD	DE	DF	DH	Weight		
LOC3-150x98	80	98	89	15	150	185	150	5	3	3 7/8	3 1/2	3/8	5 3/4	7 5/8	5 3/4	11	8		
LOC3-150x127	80	127	112	15	150	185	180	6	3	5	4 1/8	3/8	5 3/4	7 5/8	7 1/8	13	8		

HCP PUMP

HDG SERIES

SECTIONAL VIEWS

NO: 03HDG215010-0

MODEL: 80HDG21.5

10

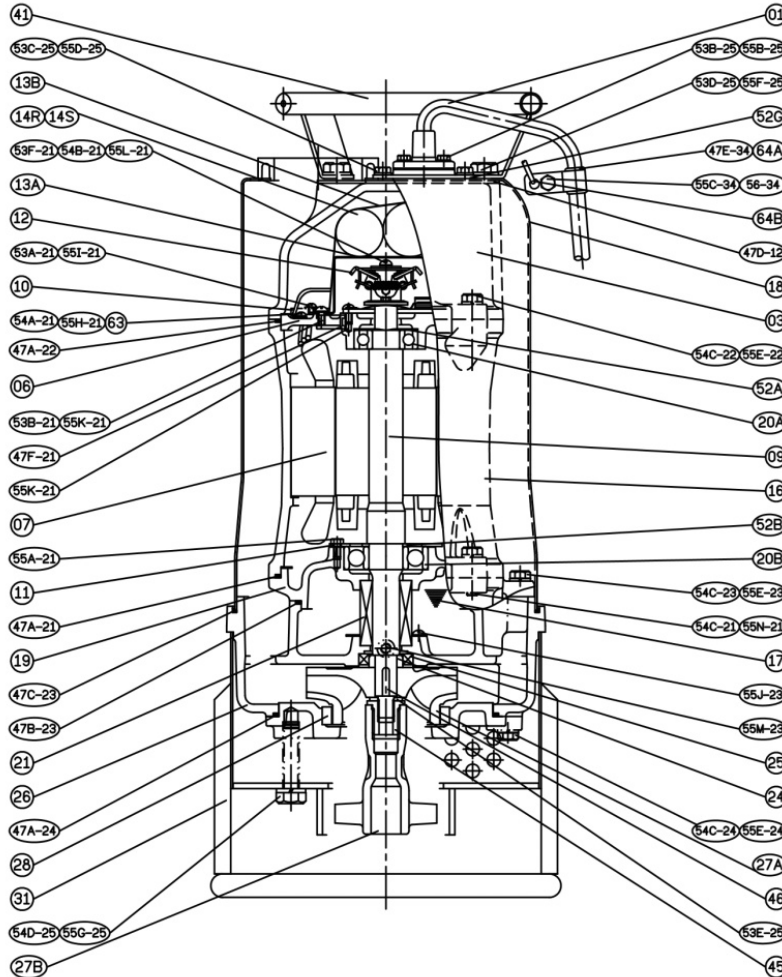

NO.	Part name	Material	QTY
01	Cable		1
03	Upper Cover	FC200	1
06	Bracket	FC200	1
07	Stator		1
09	Shaft End	SUS403	1
10	Auto-cut Protector		1
11	Bearing Fixer	SPCC	1
12	Centrifugal Switch		1
14R	Capacitor		1
14S	Start Capacitor		1
16	Motor Frame	FC200	1
17	Lubricant		
18	Outer Cover	SUS304	1
19	Bearing Bracket	FC200	1

NO.	Part name	Material	QTY
20A	Bearing		1
20B	Bearing		1
21	M. Seal	CA/CE & SiC/SiC	1
24	Oil Seal Bush	SUS403	1
25	Oil Seal	SUS304+NBR	1
26	Casing	FC200	1
27A	Impeller	HiCrFC	1
27B	Agitator	FCD700	1
28	Casing Cover+Wear Ring	FC200+HiCrFC	1
31	Strainer	SUS304	1
41	Handle	SUS304	1
46	Impeller Key	SUS304	1
47	Gasket Kit		

HCP HCP PUMP

HDG SERIES

SECTIONAL VIEWS

NO: 03HDG222010-0

MODEL: 80HDG22.2

10

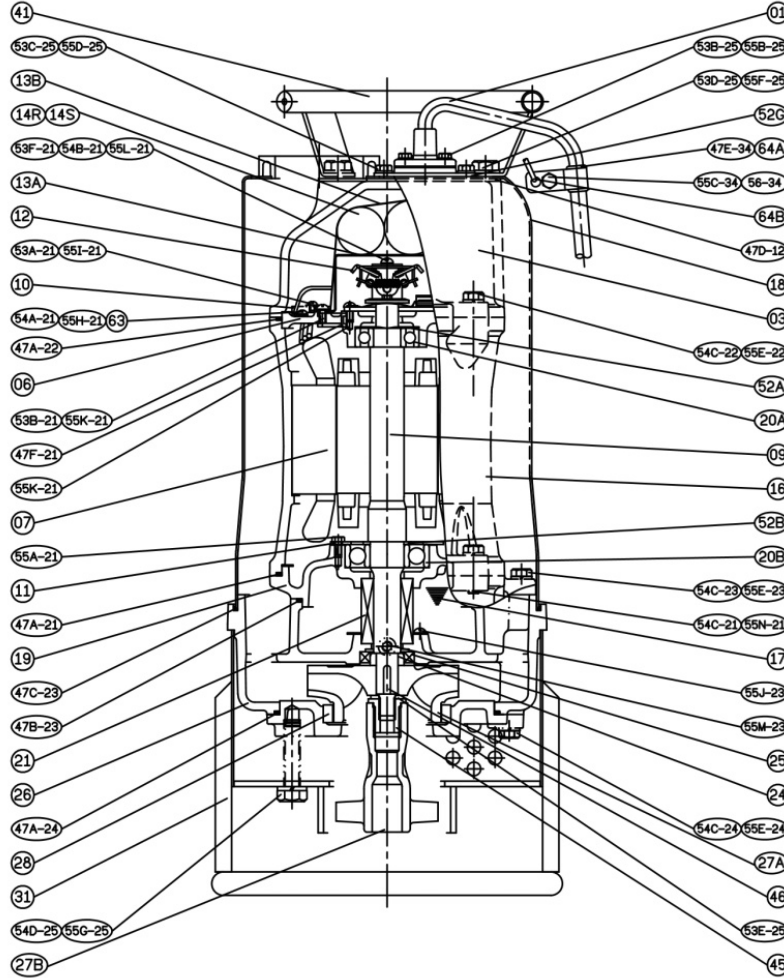

NO.	Part name	Material	QTY
01	Cable		1
03	Upper Cover	FC200	1
06	Bracket	FC200	1
07	Stator		1
09	Shaft End	SUS403	1
10	Auto-cut Protector		1
11	Bearing Fixer	SPCC	1
12	Centrifugal Switch		1
14R	Capacitor		1
14S	Start Capacitor		1
16	Motor Frame	FC200	1
17	Lubricant		
18	Outer Cover	SUS304	1
19	Bearing Bracket	FC200	1

NO.	Part name	Material	QTY
20A	Bearing		1
20B	Bearing		1
21	M. Seal	CA/CE & SiC/SiC	1
24	Oil Seal Bush	SUS403	1
25	Oil Seal	SUS304+NBR	1
26	Casing	FC200	1
27A	Impeller	HiCrFC	1
27B	Agitator	FCD700	1
28	Casing Cover+Wear Ring	FC200+HiCrFC	1
31	Strainer	SUS304	1
41	Handle	SUS304	1
46	Impeller Key	SUS304	1
47	Gasket Kit		

HCP PUMP

HDG SERIES

SECTIONAL VIEWS

NO: 03HDG222030-0

MODEL: 80HDG21.5 / 22.2

30

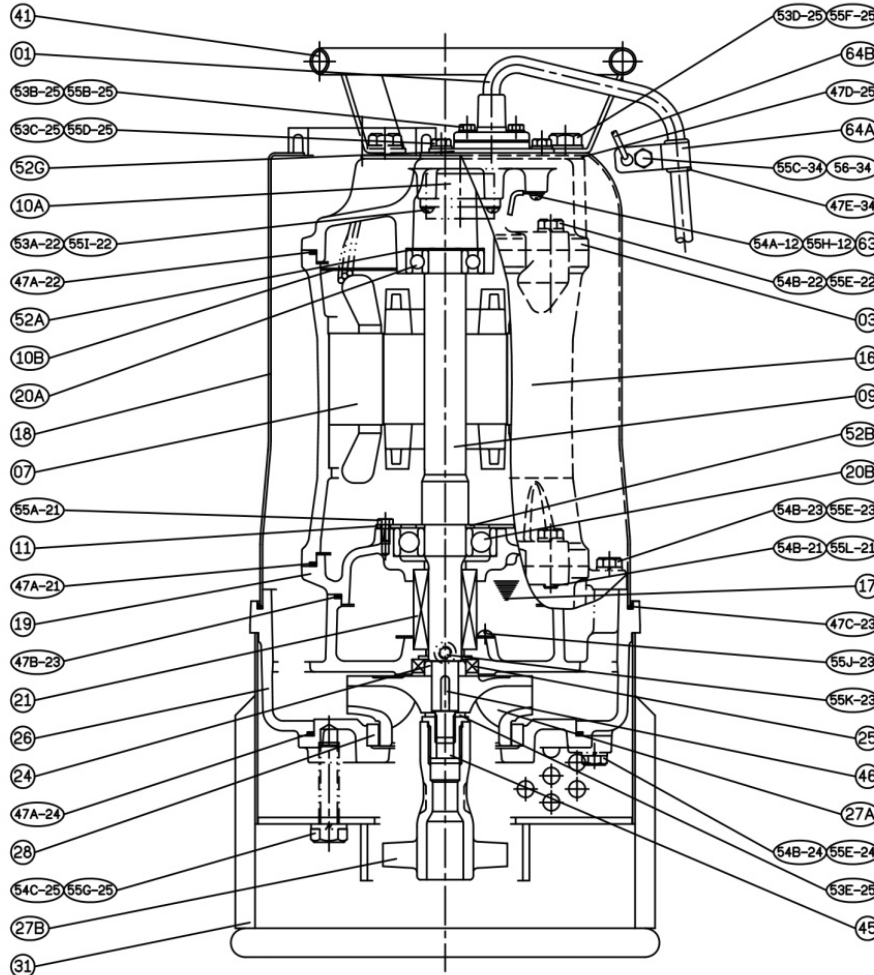

NO.	Part name	Material	QTY
01	Cable		1
03	Upper Cover	FC200	1
07	Stator		1
09	Shaft End	SUS403	1
10A	Auto-cut Protector		1
10B	Protective Plate		1
11	Bearing Fixer	SPCC	1
16	Motor Frame	FC200	1
17	Lubricant		
18	Outer Cover	SUS304	1
19	Bearing Bracket	FC200	1
20A	Bearing		1
20B	Bearing		1
21	M. Seal	CA/CE & SiC/SiC	1

NO.	Part name	Material	QTY
24	Oil Seal Bush	SUS403	1
25	Oil Seal	SUS304+NBR	1
26	Casing	FC200	1
27A	Impeller	HiCrFC	1
27B	Agitator	FCD700	1
28	Casing Cover+Wear Ring	FC200+HiCrFC	1
31	Strainer	SUS304	1
41	Handle	SUS304	1
46	Impeller Key	SUS304	1
47	Gasket Kit		

HCP HCP PUMP

HDG SERIES

SECTIONAL VIEWS

NO: 03HDG237030-0

MODEL: 80HDG23.7

30

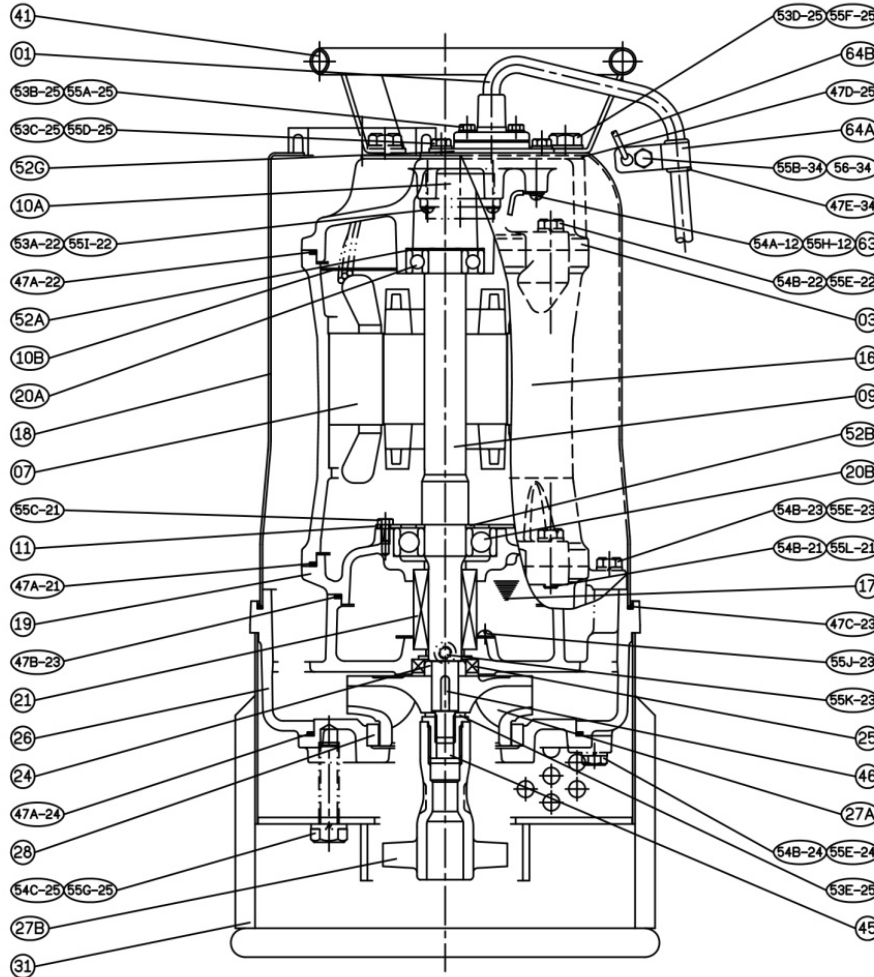

NO.	Part name	Material	QTY
01	Cable		1
03	Upper Cover	FC200	1
07	Stator		1
09	Shaft End	SUS304	1
10A	Auto-cut Protector		1
10B	Protective Plate		1
11	Bearing Fixer	SPCC	1
16	Motor Frame	FC200	1
17	Lubricant		
18	Outer Cover	SUS304	1
19	Bearing Bracket	FC200	1
20A	Bearing		1
20B	Bearing		1
21	M. Seal	CA/CE & SiC/SiC	1

NO.	Part name	Material	QTY
24	Oil Seal Bush	SUS403	1
25	Oil Seal	SUS304+NBR	1
26	Casing	FC200	1
27A	Impeller	HiCrFC	1
27B	Agitator	FCD700	1
28	Casing Cover+Wear Ring	FC200+HiCrFC	1
31	Strainer	SUS304	1
41	Handle	SUS304	1
46	Impeller Key	SUS304	1
47	Gasket Kit		

HCP HCP PUMP

HDG SERIES

SECTIONAL VIEWS

NO: 03HDG255030-1

MODEL: 80HDG25.5

30

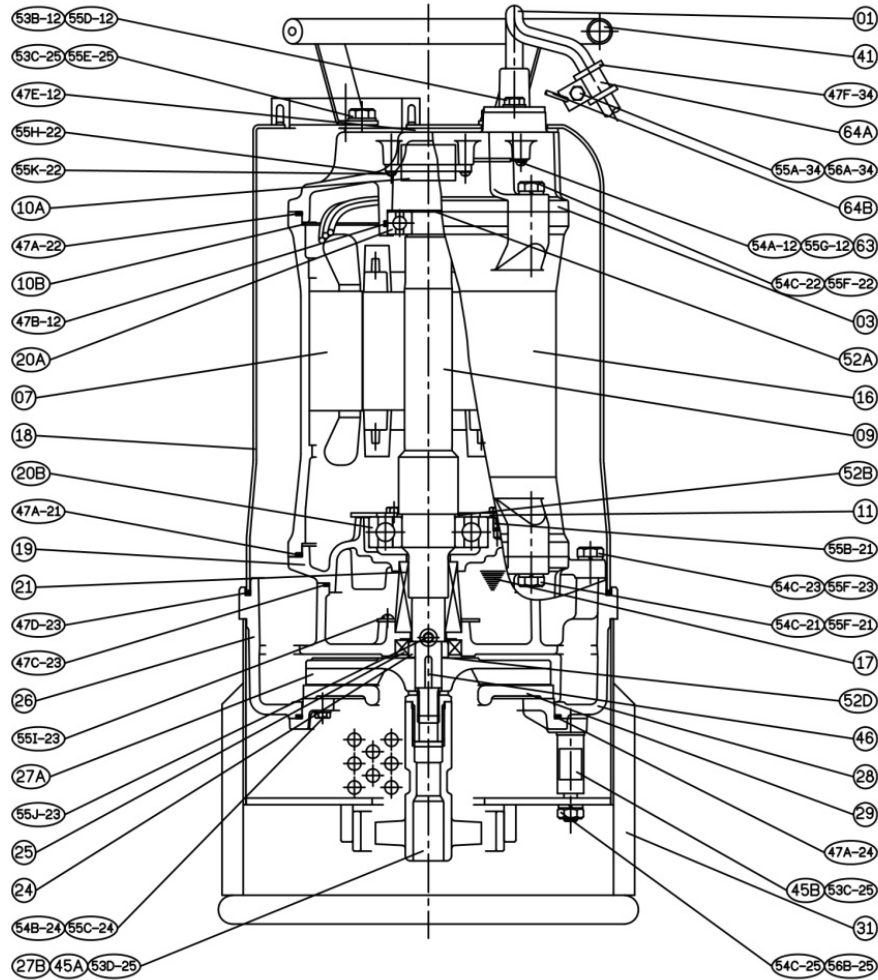

NO.	Part name	Material	QTY
01	Cable		1
03	Upper Cover	FC200	1
07	Stator		1
09	Shaft End	SUS403	1
10A	Auto-cut Protector		1
10B	Protective Plate		1
11	Bearing Fixer	SPCC	1
16	Motor Frame	FC200	1
17	Lubricant		
18	Outer Cover	SUS304	1
19	Bearing Bracket	FC200	1
20A	Bearing		1
20B	Bearing		1
21	M. Seal	CA/CE & SiC/SiC	1

NO.	Part name	Material	QTY
24	Oil Seal Bush	SUS403	1
25	Oil Seal	SUS304+NBR	1
26	Casing	FC200	1
27A	Impeller	HiCrFC	1
27B	Agitator	FCD700	1
28	Casing Cover	FC200	1
29	Wear plate	HiCrFC	1
31	Strainer	SUS304	1
41	Handle	SUS304	1
46	Impeller Key	SUS304	1
47	Gasket Kit		

HCP HCP PUMP

HDG SERIES

SECTIONAL VIEWS

NO: 06HDG275030-1

MODEL: 100HDG25.5 / 27.5 & 150HDG25.5 / 27.5

30

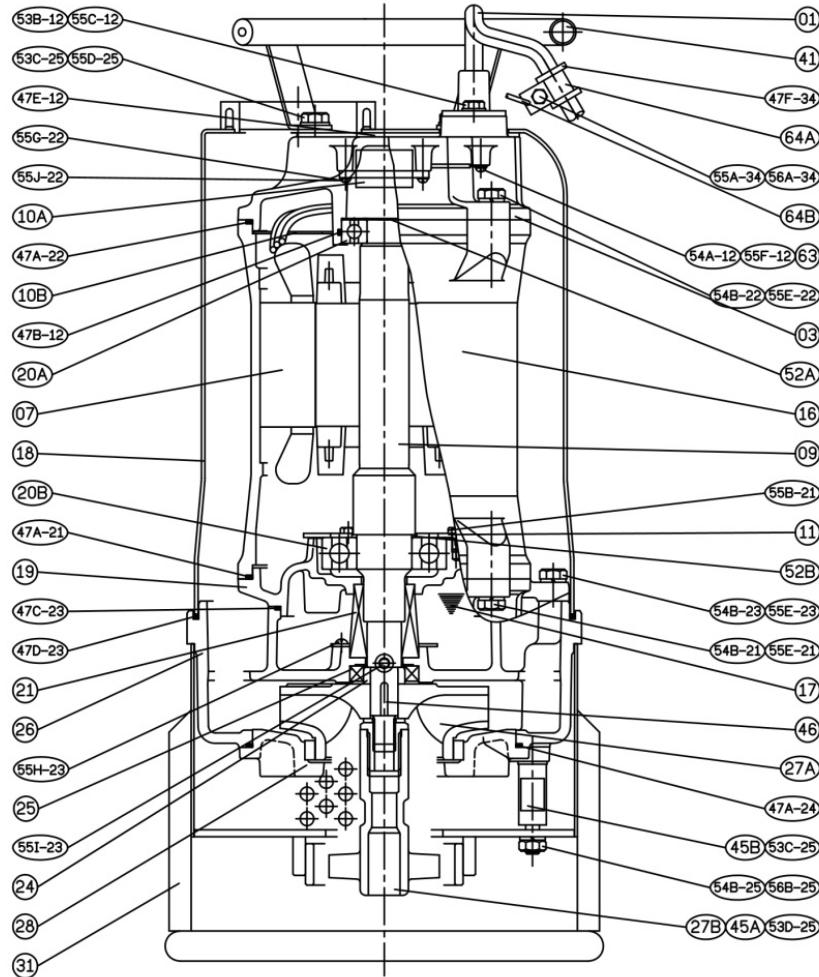

NO.	Part name	Material	QTY
01	Cable		1
03	Upper Cover	FC200	1
07	Stator		1
09	Shaft End	SUS304	1
10A	Auto-cut Protector		1
10B	Protective Plate		1
11	Bearing Fixer	SPCC	1
16	Motor Frame	FC200	1
17	Lubricant		
18	Outer Cover	SUS304	1
19	Bearing Bracket	FC200	1
20A	Bearing		1
20B	Bearing		1
21	M. Seal	CA/CE & SiC/SiC	1

NO.	Part name	Material	QTY
24	Oil Seal Bush	SUS403	1
25	Oil Seal	SUS304+NBR	1
26	Casing	FC200	1
27A	Impeller	HiCrFC	1
27B	Agitator	FCD700	1
28	Casing Cover+Wear Ring	FC200+HiCrFC	1
31	Strainer	SUS304	1
41	Handle	SUS304	1
46	Impeller Key	SUS304	1
47	Gasket Kit		



Professionalism • Innovation • Service • Commitment

A large area of the page is filled with horizontal dotted lines, providing a space for handwritten notes or answers.



Professionalism • Innovation • Service • Commitment

A large area of the page is filled with horizontal dotted lines, providing a space for handwritten notes or answers.